

LED INGROUND LIGHT



PRODUCT DETAILS



APPLICATION



• Application:

Park, courtyard, roadside, square, lawns, Walkways



Search **oteshen lighting** to follow us:



Scan the catalogue for more products:



<http://www.oteshen.com>

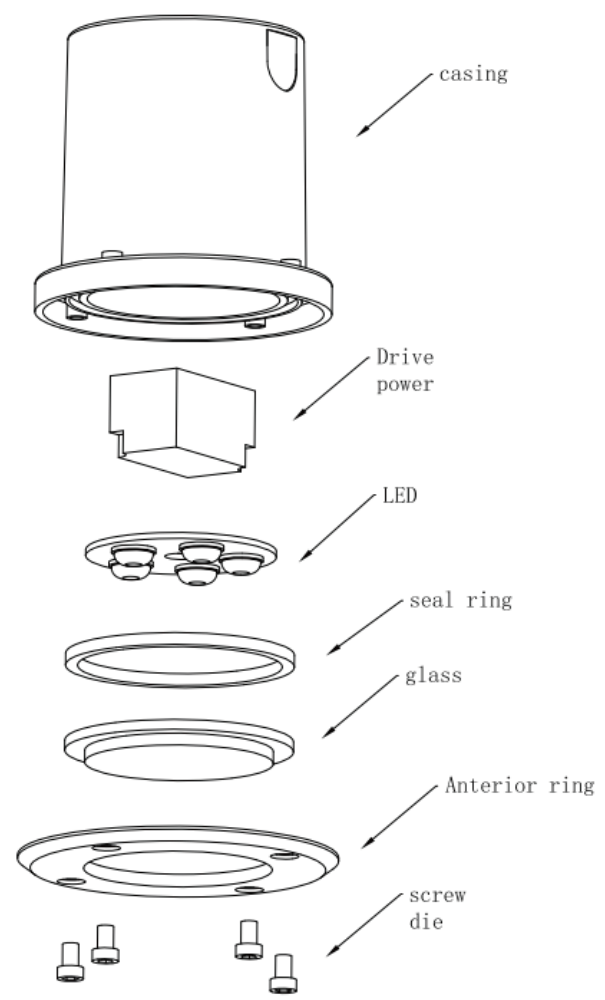
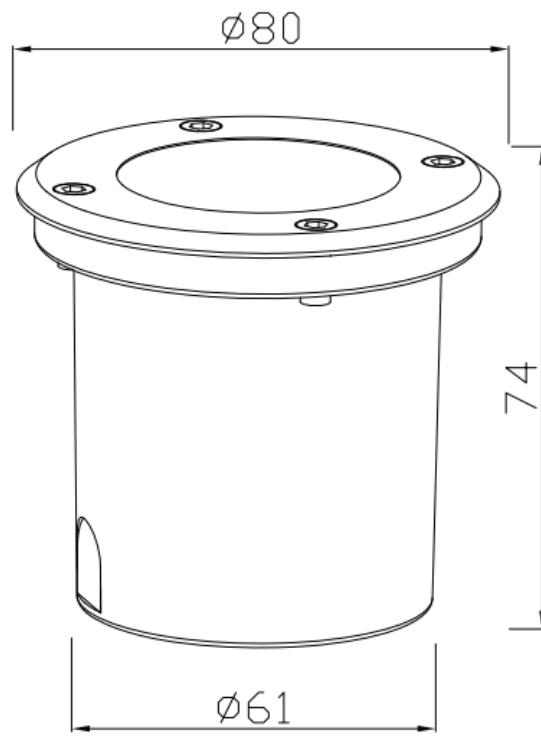

Performance & parameter of product

	Model No.	LED0740-5		
	lamp	warm white	natural white	cool white
performance parameter	lumen (lm)	220	235	260
	color temperature (K)	3000K	4000K	6000K
	CRI	≥80		
	type of LED	SMD		
	beam angle	/		
	decay rate (%)	1000 hours no more than 3%		
	total power (W)	3W		
	lifespan (Hrs)	≥30000Hrs		
	high voltage testing	1500Vac/1min		
	LED parameter	lighting efficiency	≥50lm/W	
chip quantity		5PCS		
series-parallel way		1C5B		
voltage		/		
current		/		
driver parameter	input parameter	100 ~ 240VAC, 50/60Hz		
	power factor	>0.5		
	output parameter	/		
structure parameter	material	Stainless steel+PP		
	dimension	Φ80*74mm		
	cut-out	Φ73mm		
	protection class	Class II		
	IP	IP67		
environment parameter	operating temperature	-25°C ~ 50°C、10% ~ 90% R.H.		
	storage temperature	-30°C ~ 85°C、0% ~ 95% R.H.		

Installation Instructions:

1. Switch off the power;
2. Dig The right hole in the ground. (Pic 1)
3. Lay The power cord (Make sure the seal is watertight) . (Pic 2) ;
4. Connect the power 100-240VAC. (Pic 3) ;
5. Installation of luminaires. (Pic 4) ;
6. Switch on the power if above steps are done properly without any mistakes.

